



TS 83

Easy-action
Door Closer

Easy-action door closer with “thinking” backcheck

Easy to fix and even easier to adjust. The door closer for almost every door size and application.

Decades of experience have gone into the development of the DORMA TS 83. The result is user comfort coupled with outstanding versatility. It can be adjusted to suit almost all types of door.

It can even be supplied with additional anti-corrosion protection for exposed applications or aggressive conditions.

Fixing couldn't be easier – and last but not least – it's engineered for excellence.

Certified to ISO 9001.

Plus points

For the trade

- Low inventory costs and reduced stocking requirements thanks to streamlined product range.
- Practical and effective solutions to meet special applications thanks to comprehensive choice of accessories.

For the installer

- Easy to fix.
- Can be “tailored” to the requirements of the door by simple adjustment.
- Just one model for RH (DIN-R, ISO 5) and LH (DIN-L, ISO 6) doors, and for standard and frame/lintel fixing.
- Spring strength range EN 3–6 to suit virtually every application.

For the specifier/architect

- Compact closer design and sturdy flat-form arm assembly.
- Wide range of standard functions supplemented by optional extras.
- Suitable for fire doors.

For the user

- Optimum wall and door protection thanks to “thinking” backcheck.
- Closing speed virtually unaffected by temperature fluctuations.
- Proportionately low opening resistance thanks to high mechanical efficiency.



The TS 83 conforms to most recognised international standards and complies with the

requirements and/or recommendations of the following: CERTIFIRE approved for fire doors; Ref. CF 118

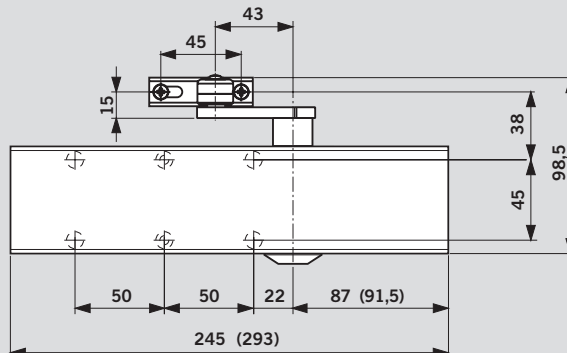
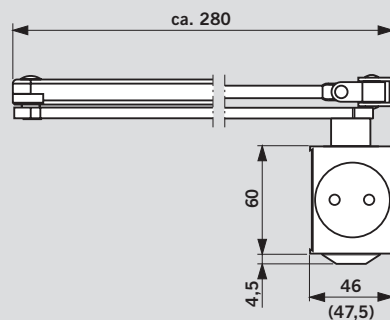

() = EN 7

Data and features		TS 83	
Variable closing force	Spring strength	EN 3 – 6	EN 7
Standard doors ¹⁾	≤ 1400 mm ≤ 1600 mm	● –	– ●
External doors, outward opening ¹⁾	≤ 1400 mm ≤ 1600 mm	● –	– ●
Fire and smoke check doors ¹⁾	≤ 1400 mm ≤ 1600 mm	● –	– ●
Non-handed		●	●
Arm assembly type	Standard	●	●
	Flat-form	●	●
	Slide channel	–	–
Closing force variable by means of adjustment screw		●	–
Closing speed adjustable at 2 separate valves	180° - 15°	●	–
	15° - 0°	●	–
Closing speed variable by means of valve adjustment		–	●
Adjustable latching action	by arm	●	●
Backcheck	self-regulating	●	●
	adjustable at valve	●	●
Delayed action variable at valve		○	–
Hold-open		○	○
Weight in kg		1.7	3.3
Dimensions in mm	Length	245	293
	Overall depth	46	47.5
	Height	60	60
Door closer tested to EN 1154		●	●
CE mark for construction products		●	●

● yes – no ○ option

¹⁾ For applications involving particularly heavy or wide doors, and doors which have to close against wind resistance, the next highest closer size or a higher spring strength should be applied.

Standard and optional functions

With “thinking” backcheck – Model BC/ÖD

Thanks to an innovative design concept, the resistance developed by this backcheck system as the door is opened beyond approx. 70° is directly proportional to door acceleration. It is almost imperceptible when the door is opened slowly. However, if the door is opened hastily, the backcheck responds in equal measure.

And if the door should be flung open at speed – whether deliberately, thoughtlessly, accidentally or as a result of a gust of wind – the backcheck reacts at full strength, protecting the wall and door from damage.

If no backcheck function is required, the system can simply be switched off.

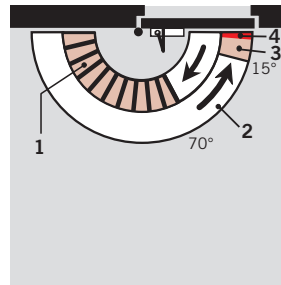

- 1 Self-regulating backcheck
- 2 Infinitely variable closing speed in the range 180° – 15°
- 3 Infinitely variable closing speed in the range 15° – 0°
- 4 Adjustable latch range (by arm)

With additional delayed action – Model BC/ÖD + DC/SV

This model with its additional, integrated delayed action enables the closing cycle to be retarded within an adjustable range from 180° – 70° so that disabled persons, mothers with prams and people carrying bulky items are able to pass through the door without difficulty.

This model can also be used for fire doors.

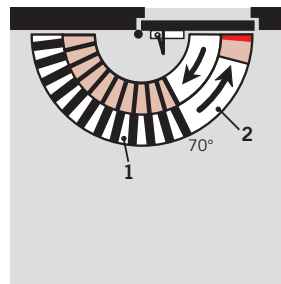
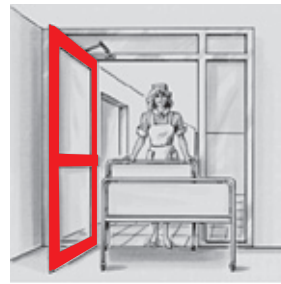

- 1 Adjustable delayed action
- 2 Fully controlled closing with adjustable speed

With hold-open – Model with hold-open arm

Combining the TS 83 with a hold-open arm enables the door to be held open at an appropriate angle (up to approx. 150°).

The hold-open function in the standard hold-open arm can be switched on and off by the user by simply pressing a switch.

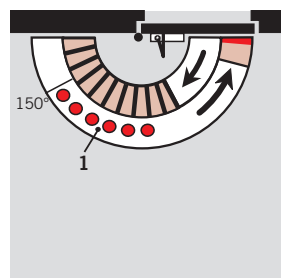

- 1 Hold-open range

Hold-open arms are not approved for fire and smoke check doors.

Door leaf fixing, pull side (example shows LH (ISO 6) door; RH (ISO 5) doors mirrored arrangement)

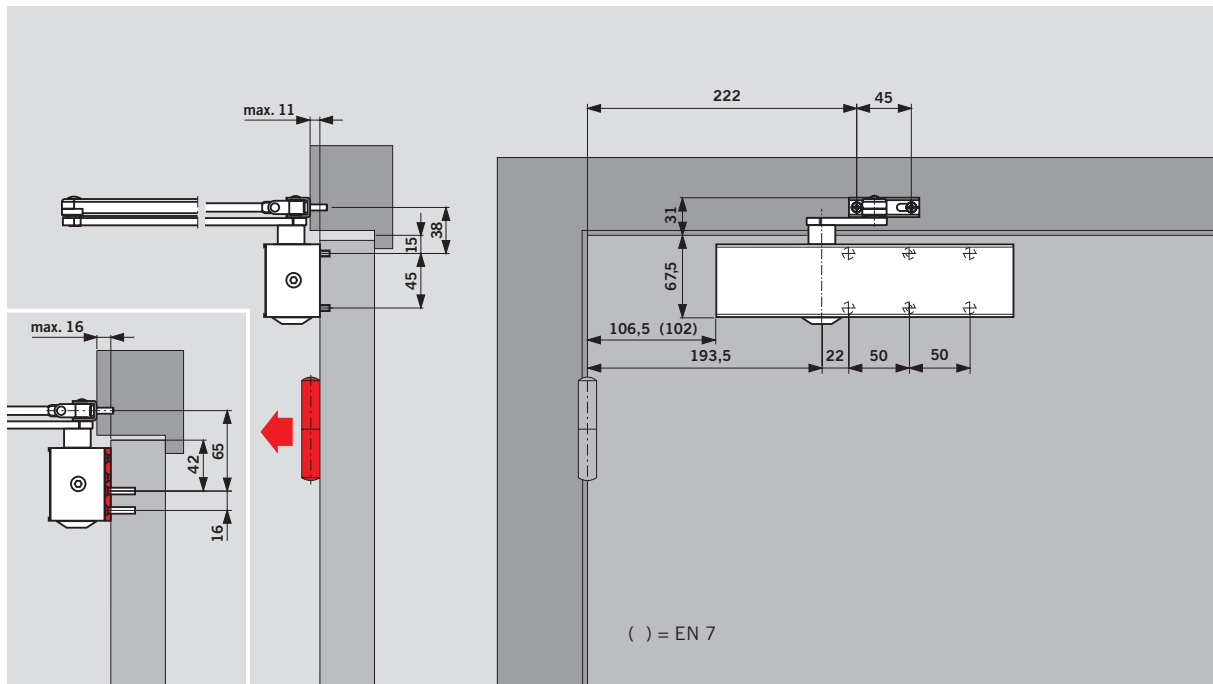

Door leaf fixing with hold-open arm

(example shows LH (ISO 6) door; RH (ISO 5) doors mirrored arrangement)

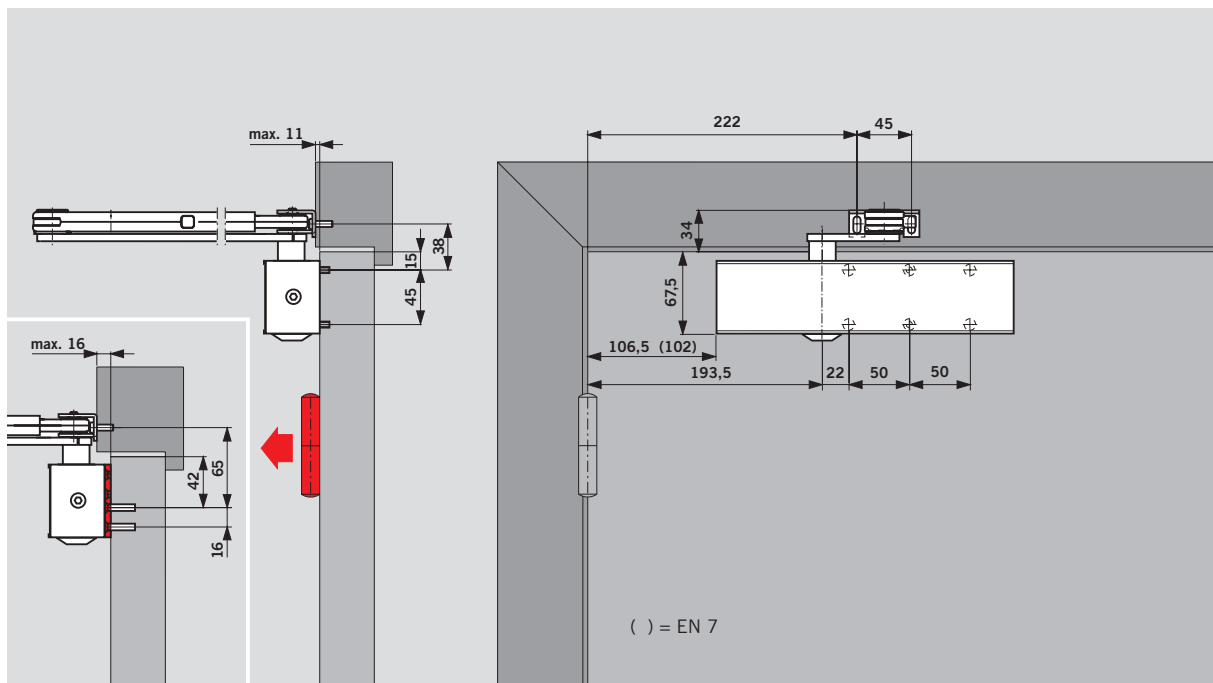

Transom fixing, push side (example shows LH (ISO 6) door; RH (ISO 5) doors mirrored arrangement)

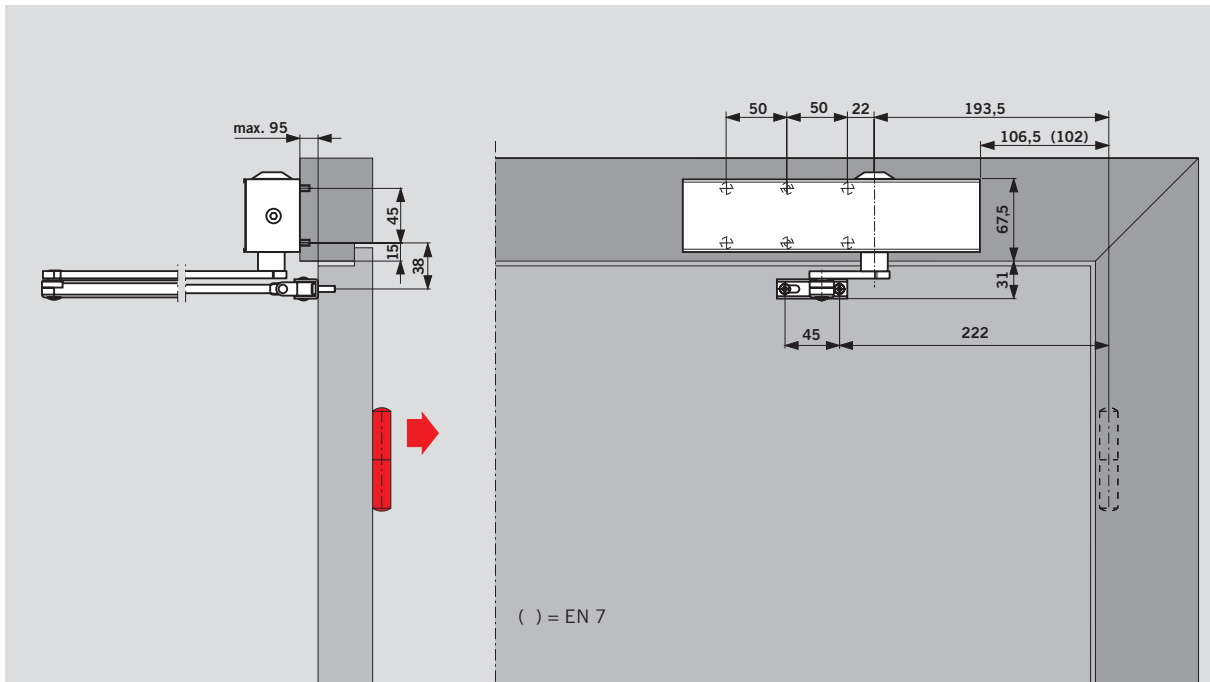

In the case of fire doors, door closers may only be transom-fixed where appropriate approval has been obtained in the form of a certificate or test report issued by an accredited testing agency.

Transom fixing:

With transom-fixed closers, the backcheck only responds at between 85° and 90°, depending on the depth of reveal and type of door hinge involved; the delayed action, on the other hand, releases the door at an earlier point in its closing sweep.

Mounting backplate TS 83

For use with fire and smoke check doors and also as an intermediate plate when direct fixing to the door is not possible; with fixing hole pattern to EN 1154, supplement 1.

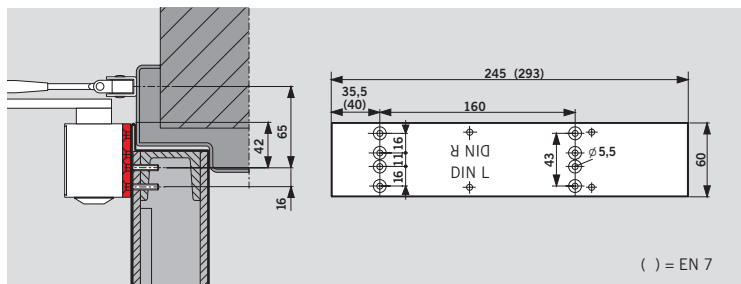

() = EN 7

Arm bracket adapter plate TS 73 V / TS 83

For fixing the arm bracket to particularly narrow door frames.

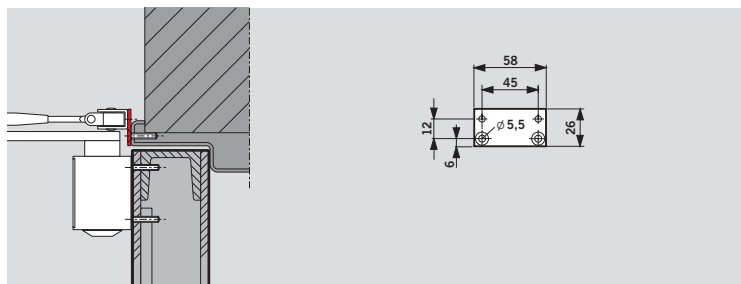

Angle bracket TS 83

For frame/lintel fixing of the closer on the push side of doors with deep reveals.

On fire and smoke check doors, proof of suitability required in relation to the individual door concerned.

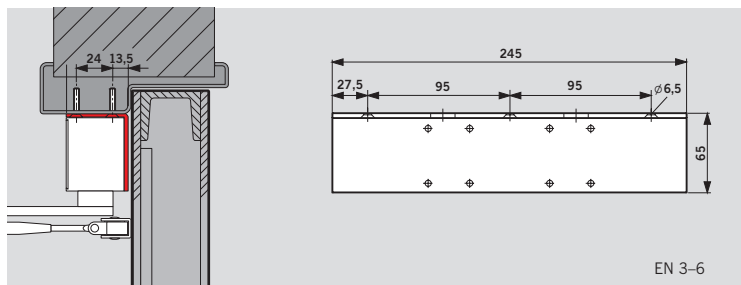

EN 3-6

Drop plate TS 73 V / TS 83

For installation on frame when direct fixing of closer is not possible.

On fire and smoke check doors, proof of suitability required in relation to the individual door concerned.

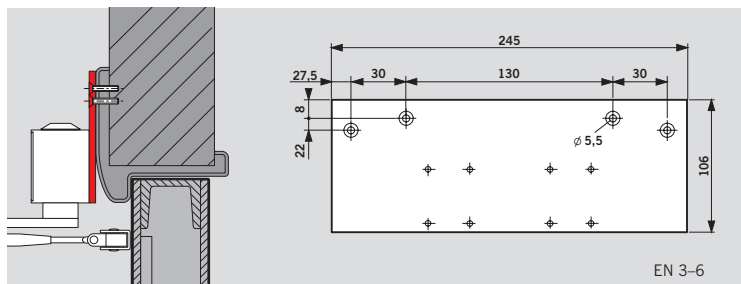

EN 3-6

Parallel arm bracket TS 73 V / TS 83

For parallel arm installation on the push side (see fixing instructions for dimensions).

On fire and smoke check doors, proof of suitability required in relation to the individual door concerned.

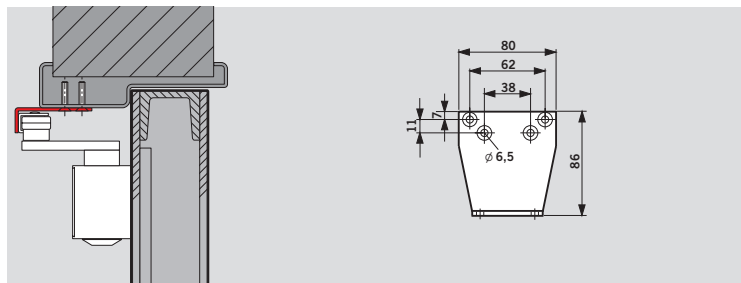





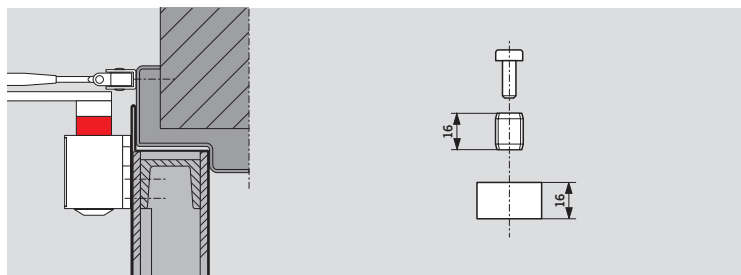







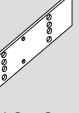

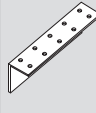
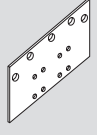



Spindle extension TS 73 V / TS 83

For increasing the distance between the closer and the arm assembly in the case of doors with a high overlap; 16 mm high.



Supply and accessory information

Closer body TS 83	Standard arm	Standard arm anti-corrosive type (AC)	Flat-form arm	Hold-open arm with on/off switch	Mounting backplate	Arm bracket adapter plate	Angle bracket	Drop plate	Parallel arm bracket	Spindle extension 16 mm
	 □ 220023xx		 □ 830001xx	 □ 220030xx	 EN 3 – 6 380001xx EN 7 830011xx	 830014xx	 EN 3 – 6 380003xx	 EN 3 – 6 380002xx	 280066xx	 83003705
Size EN 3 – 6 BC/ÖD ■ 380101xx					#	#	#	#	#	#
Size EN 3 – 6 BC/ÖD+DC/SV ■ 380201xx					#	#	#	#	#	#
Size EN 3 – 6 BC/ÖD (AC)		■ 38030301			#	#	#	#	#	#
Size EN 7 BC/ÖD ■ 830501xx					#	#			#	#

Order No.:

■ = Body only

□ = Arm only

■□ = Closer with arm, complete

= Optional accessory

Colour*)

silver

white (RAL 9016)

other

xx

01

11

09

*Anti-corrosion protected closers and arms available in silver (01) only.

Specification text TS 83 EN 3 – 6

DORMA TS 83 rack and pinion door closer; with adjustable power size EN 3 – 6, according to EN 1154, carries the CE mark, integral self-regulating backcheck; closing speed adjustable in two independent ranges and adjustable latch action. Non-handed.

Model

- with additional, adjustable delayed action
- anti-corrosion protected (AC)
- with standard arm
- with flatform arm
- with hold-open arm with switch

Accessories

Colour

- silver
- white (sim. RAL 9016)
- other (sim. RAL _____)

Model make DORMA TS 83
 TS83

Specification text TS 83 EN 7

DORMA TS 83 rack and pinion door closer; with power size EN 7, according to EN 1154, carries the CE mark, integral self-regulating backcheck; adjustable closing speed and adjustable latch range. Non-handed.

Model

- with standard arm
- with flatform arm
- with hold-open arm with switch

Accessories

Colour

- silver
- white (sim. RAL 9016)
- other (sim. RAL _____)

Model make DORMA TS 83
 TS83



Door Control



Automatic



**Glass fittings
and Accessories**



**Security Time
and Access (STA)**



Movable Walls

Door Control Division worldwide

Central Europe

DORMA GmbH + Co. KG
DORMA Platz 1
D-58256 Ennepetal
Phone +49 2333 793-0
Fax +49 2333 793-495

Australasia

DORMA Door Controls Pty. Ltd.
52, Abbott Road
Hallam/Victoria 3803
Australia
Phone +61 3 8795 0666
Fax +61 3 8795 0280

China/Hong Kong

DORMA Door Controls
(Suzhou) Co. Ltd.
No. 9, Hong Feng Road
Suzhou Singapore Industrial Park
Suzhou, 215021
P.R. of China
Phone +86 512 67612481
Fax +86 512 67614582

Emerging Markets

DORMA Door Controls Pte. Ltd.
Room 701, Technology Plaza
651 King's Road
North Point
Hong Kong
Phone +852 25034632
Fax +852 28875370

France

DORMA GmbH + Co. KG
DORMA Platz 1
D-58256 Ennepetal
Phone +49 2333 793-0
Fax +49 2333 793-495

France

DORMA Door Controls (Pty.) Ltd.
Kings Court
4A Mineral Crescent
ZA-2000 Crown/Gauteng
South Africa
Phone +27 11 8300280
Fax +27 11 8300291

Far East

DORMA Far East Pte. Ltd.
No. 31 Gul Lane
Singapore 629425
Phone +65 6268 7633
Fax +65 6265 7995

France

DORMA France S.A.S.
Zone Europarc
Immeuble Mega 42
42, Rue Eugène Dupuis
F-94046 Créteil Cedex
Phone +33 1 41942400
Fax +33 1 41942401

Gulf

DORMA Gulf Door Controls FZE
Jebel Ali Free Zone South
Plot No. S 20135
Road No. SW 301 G
P.O. Box 17268
Dubai – United Arab Emirates
Phone +971 4 8020400
Fax +971 4 8869100/8869101

North America

DORMA Architectural Hardware
DORMA Drive, Drawer AC
Reamstown, PA 17567-0411
Phone +1 800 5238483
Fax +1 800 2749724

Scanbalt

DORMA Danmark A/S
Sindalvej 6-8
DK-2610 Rødovre
Phone +45 44 543000
Fax +45 44 543001

South America

DORMA Sistemas de Controles
para Portas Ltda.
Av. Piracema, 1400
Centro Empresarial Tambore
CEP 06400-933 Barueri/
São Paulo, Brasil
Phone +55 11 46899280
Fax +55 11 46899215

South-East Europe

DORMA AUSTRIA GmbH
Pebering Strass 22
A-5301 Eugendorf
Phone +43 6225 284880
Fax +43 6225 28491

South Europe

DORMA Italiana S.r.l.
Via. Canova 44/46
I-20035 Lissone (MI)
Phone +39 039 244031
Fax +39 039 24403310

DORMA Ibérica, S.A.

Camino San Martin de la Vega, 4
E-28500 Arganda del Rey
(Madrid)
Phone +34 91 8757850
Fax +34 91 8757881

UK/Ireland

DORMA UK Ltd.
Wilbury Way
Hitchin
GB-Hertfordshire SG4 0AB
Great Britain
Phone +44 1462 477600
Fax +44 1462 477601